

**RGBWA+UV**

## **CS-B72B BATTERY PAR CAN User Manual**

KEEP THIS MANUAL FOR FUTURE NEEDS

color'sage®

📍 Factory: No.186, South Tingshi Road, Shijing Town, Baiyun District, Guangzhou, China.

☎ +86-20-3110 3721

✉ info@color-sage.com

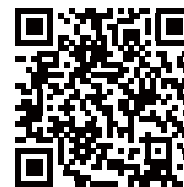

[www.color-sage.com](http://www.color-sage.com)



YOUTUBE



FACEBOOK

## 1. SAFETY INSTRUCTIONS

### \*CAUTION!

**Becareful with your operations. With a dangerous voltage you cansuffer a dangerous electric shock when touching wires!**

This device has left the factory in perfect condition. In order to maintain this condition and to ensure a safe operation, it is absolutely necessary for the user to follow the safety instructions and warning notes written in this user manual.

### \*IMPORTANT!

**Damages caused by the disregard of this user manual are not subject to warranty. The dealer will not accept liability for any resulting defects or problems.**

If the device has been exposed to temperature changes due to environmental changes, do not switch it on immediately. The arising condensation could damage the device.

Leave the device switched off until it has reached room temperature.

This device falls under protection-class I. Therefore it is essential that the device be earthed.

The electric connection must carry out by qualified person.

The device shall only be used with rate voltage and frequency.

Make sure that the available voltage is not higher than stated at the end of this manual.

Make sure the power cord is never crimped or damaged by sharp edges.

Always disconnect from the mains, when the device is not in use or before cleaning it.

Only handle the power cord by the plug. Never pull out the plug by tugging the power cord.

During initial start-up some smoke or smell may arise. This is a normal process and does not necessarily mean that the device is defective, it should decrease gradually.

Please don't project the beam onto combustible substances.

Fixtures cannot be installed on combustible substances, keep more than 50cm distance with wall for smooth air flow, so there should be no shelter for fans and ventilation for heat radiation.

If the external flexible cable or cord of this luminaire is damaged, it shall be exclusively replaced by the manufacturer or his service agent or a similar qualified person in order to avoid a hazard.

## 2. UNPACKING

Thank you for choosing our CS-B72B LED BATTERY PAR CAN.

For your own safety, please read this manual before installing the device. This manual covers the important information on installation and applications. Please install and operate the fixture with following instructions.

This LED BATTERY PAR CAN use 6PCS\*12W LEDs. Charging about 5-6 hours can use about 4.5 hours of full color, or about 20 hours of single color.

This product is used to enliven atmosphere for family gatherings, KTV box, disco ballroom, ballroom, nightclub, disco, bar, mall, wedding, square, park, etc.

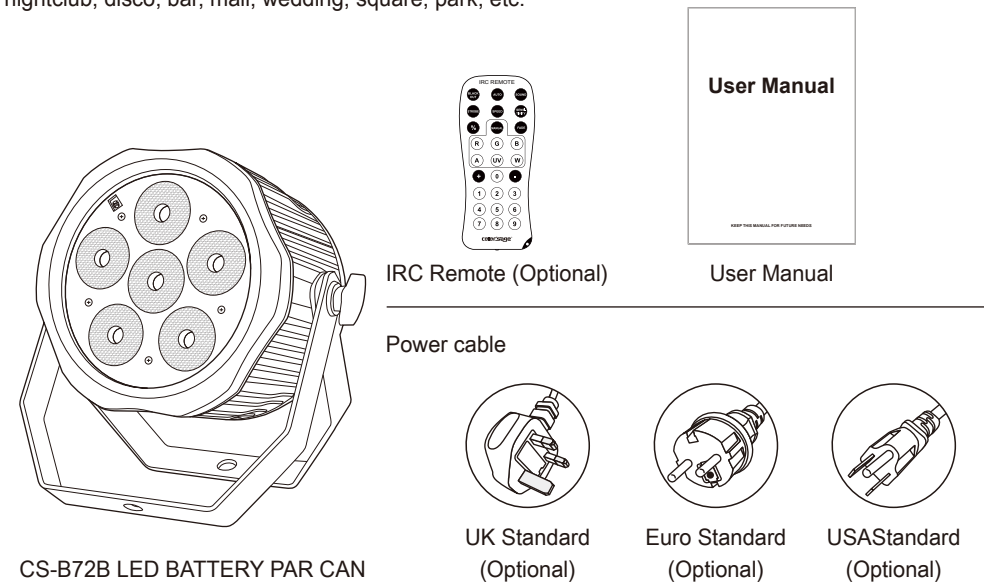

CS-B72B LED BATTERY PAR CAN

IRC Remote (Optional)

User Manual

User Manual

Power cable

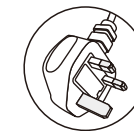

UK Standard (Optional)

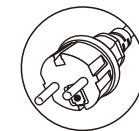

Euro Standard (Optional)

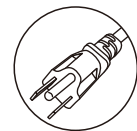

US Standard (Optional)

## 3. FEATURES & SPECIFICATIONS

### Function:

1. Master/Slave,
2. Sound activated,
3. Automatic
4. DMX 512
5. Wireless DMX (Optional)
6. IR remote control (Optional)

7. LED dimmer,
8. Color jumping,
9. Color Gradual change
10. Color Pulse change
11. Strobe

### Specifications:

LED quantities: 6pcs\*12W LEDs  
 Input Voltage: AC90V-240V, 50/60HZ  
 Power consumption: 72W  
 Channel: 6/10 CH  
 Beam Angle: 40°  
 Display Screen: LCD display  
 Battery Type: Lithium battery  
 Battery Charging Time: About 5-6 hours  
 Battery Using Hours: About 4.5 hours of full color, about 20 hours of single color.  
 Color: RGBWA+UV 6 in 1  
 Material Science: Iron alloy

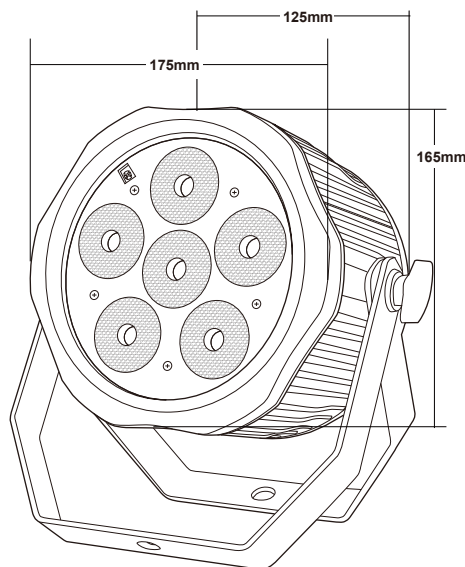

### Packing & weight:

Size: 240mm\*210mm\*165mm  
 Net Weight: 3.66kg  
 Packing: 250mm\*250mm\*200mm  
 Gross Weight: 4kg

## 4. OPERATION INSTRUCTIONS

01. Don't turn on the fixture if it's been through severe temperature difference like after transportation because it might damage the light due to the environment changes. So make sure to operate the fixture until it is in normal temperature.
02. This light should be keep away from strong shaking during any transportation or movement.
03. Don't pull up the light by only the head, or it might cause damages to the mechanical parts.
04. Don't expose the fixture in overheat, moisture or environment with too much dust when installing it. And don't lay any power cables on the floor. Or it might cause electronic shock to the people.

05. Make sure the installation place is in good safety condition before installing the fixture.
06. Make sure to put the safety chain and check whether the screws are screwed properly when installing the fixture.
07. Make sure the lens are in good condition. It's recommended to replace the units if there are any damages or severe scratch.
08. Make sure the fixture is operated by qualified personnel who knows the fixture before using.
09. Keep the original packages if any second shipment is needed.
10. Don't try to change the fixtures without any instruction by the manufacturer or the appointed repairing agencies.
11. It is not in warranty range if there are any malfunctions from not following the user manual to operate or any illegal operation, like shock short circuit, electronic shock, lamp broke, etc.

## 5. MENU OPERATIONS

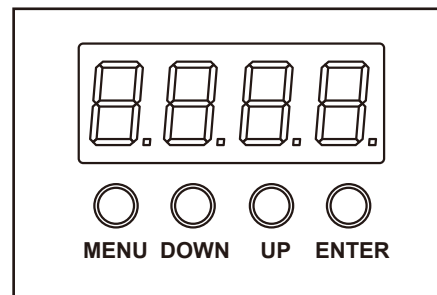

**MENU:** Access the menu.

**DOWN: Reduction key or key under the selected;** decrease the value function down menu.

**UP: Add key or selection on the key;** increase the value function, shift on the menu.

**ENTER:** It is used to select and confirm/store the current selection.

MENU	Function/Value	Instructions
d001	001-512, 6 Channel mode.	DMX512 address setting
A001	10 Channel mode, 001-512	DMX512 address setting
S-SL	SL/FA, DMX512 dimming speed setting	SL: slow dimming; FA: fast dimming
d-Ho	Ho/of, DMX signal loss processing mode setting	Ho: keep the last DMX signal state; oF: Turn off all LEDs
rFon	ON-OFF	Wireless dmx control
Iron	ON-OFF	IR remote control
r255	Red dimming/0-255	0-255 from dark to bright
G255	Green dimming/0-255	0-255 from dark to bright
b255	Blue dimming/0-255	0-255 from dark to bright
u255	White dimming/0-255	0-255 from dark to bright
Y255	Amber dimming/0-255	0-255 from dark to bright
P255	UV dimming/0-255	0-255 from dark to bright
I255	IR remote control/0-255	IR remote control brightness
FF00	Strobe speed/0-255	0-255 from slow to fast
CL01	Static color selectable/ 0-255	15 kinds static color selectable
CC12	Color jumping/0-15	0-15, Speed from slow to fast
DE15	Color gradual change/0-15	0-15, Speed from slow to fast
CP13	Color Pulse change/ 0-15	0-15, Speed from slow to fast
SU13	Sound control/0-15	Voice sensitivity, 0-15 from low to high
t 30	Current temperature display/0-99	when not used the display will show : t ---
VEr1		Version number
rSEt		Reset

## 6. DMX CHANNELS

### 6 Channel

Channel	Function/Value	Instructions
1	Red dimming/1-255	0-255 from dark to bright
2	Green dimming/1-255	0-255 from dark to bright
3	Blue dimming/1-255	0-255 from dark to bright
4	White dimming/1-255	0-255 from dark to bright
5	Amber dimming/1-255	0-255 from dark to bright
6	UV dimming/1-255	0-255 from dark to bright

### 10 Channel

Channel	Function/Value	Instructions
1	Red dimming	0-255 from dark to bright
2	Green dimming	0-255 from dark to bright
3	Blue dimming	0-255 from dark to bright
4	White dimming	0-255 from dark to bright
5	Amber dimming	0-255 from dark to bright
6	UV dimming	0-255 from dark to bright
7	Master dimmer	RGBWAUV master dimmer, 0-255 from slow to fast
8	Master strobe	RGBWAUV master strobe, 0-255 from slow to fast
9	Function selection	0-50 no function, 51-100 15 kinds of color output, controlled by CH10, 101-150 Color jumping, 151-200 Color Gradual change, 201-250 Color Pulse change, 251-255 Sound control.
10	Function speed	Function speed, 0-255 from slow to fast (When color output, it is color selection )

## 7. Remote Controller Using (Optional)

### BLACK OUT Mode

It is a remote switch, Press "BLACK OUT" one time, it will open the IR remote model, and it will default to color jump mode "CC12", also will enter to the previously saved mode if some mode has been saved, press "BLACK OUT" one time again, it will Exit the remote control function and save the current settings.

### AUTO Mode

Automatic mode will enable you to run the automatic programs on the product.

To turn on Automatic mode:

1. Press "AUTO" on the remote controller.
2. Press "+" or "-" to choose between the different auto programs.

### SOUND Mode

Sound-Active mode will enable the product to respond to the music.

To turn on Sound-Active mode:

1. Press "SOUND" on the remote controller.
2. Press "+" or "-" to choose between the different sound programs.

### FADE Mode

It is a color gradient mode.

1. Press "FADE" on the remote controller.
2. Press "FADE" again to turn off the Fade mode.
3. Press "+" or "-" to either increase or decrease the speed of the program.

### MANUAL Mode

1. Press "MANUAL" one time, the menu display show "dlon", turn on the remote controller.
2. Press "R", "G", "B", "W", "A" or "UV" (red, green, blue, white, amber, UV) to choose your Wanted colour. press the 1st time, it is 20% brightness, press the 2nd time, it is 40% brightness, press the 5th time, it is 100% brightness. Press the 6th time, turn off the manual color which you chosen.

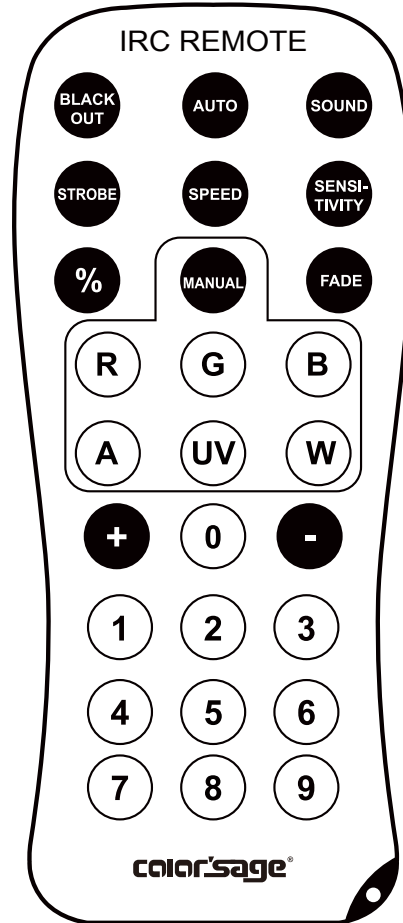

### % Mode

Adjust the brightness of RGBWAUV color, press the 1st time, it is 10% brightness, press the 2nd time, it is 20% brightness, ..., press the 10th time, it is 100% brightness.

### NUMBER 0-9

0-9 kinds Static color mode, press one time for your wanted color, Press "+" or "-" to either increase or decrease brightness.

### STROBE Mode

It should be worked with Auto mode /sound mode/fade mode/manual mode/0-9 static color model together press the "STROBE" one time, it is 1/8 speed, press the 2nd time, it is 2/8 speed, press the 8th time, it is 100% speed.

### SENSITIVITY Mode

It is reset function, press it one time, enter the initial function press it once again, restore factory settings, exit the remote control and enter A01.

### SPEED Mode

This product does not support this feature for now.

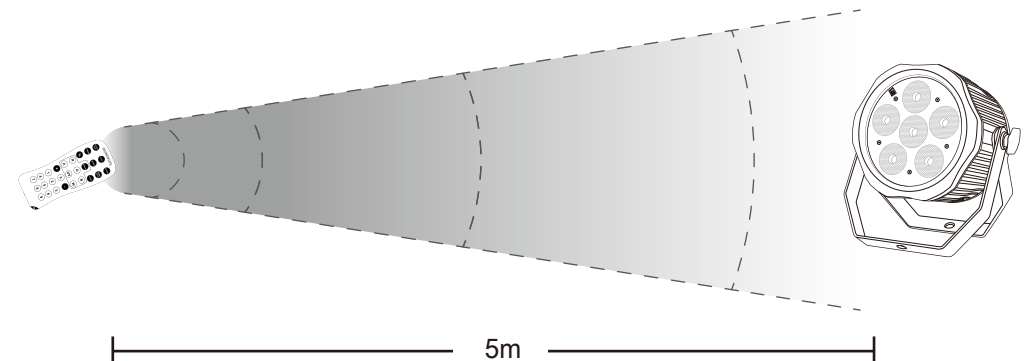

Please use this remote controller within remote control range.

## **8. MAINTENANCE AND CLEANING**

The following points have to be considered during the inspection:

1. All screws for installing the devices or parts of the device have to be tightly connected and must not be corroded.
2. There must not be any deformations on the housing, color lenses, fixations and installation spots (ceiling, suspension, trussing).
3. Mechanically moved parts must not show any traces of wearing and must not rotate with unbalances.
4. The electric power supply cables must not show any damage, material fatigue or sediments.

Further instructions depending on the installation spot and usage have to be adhered by a skilled installer and any safety problems have to be removed

### **\*CAUTION!**

**Disconnect from mains before starting maintenance operation.**

In order to make the lights in good condition and extend the life time, we suggest a regular cleaning to the lights.

1. Clean the inside and outside lens each week to avoid the weakness of the lights due to accumulation of dust.
2. Clean the fan each week.
3. A detailed electric check by approved electrical engineer each three month, make sure that the circuit contacts are in good condition, prevent the poor contact of circuit from overheating.
4. Frequent cleaning. Please use a moist, lint- free cloth. Never use alcohol or solvents.

There are no serviceable parts inside the device. Please refer to the instructions under "Installation instructions".

Should you need any spare parts, please order genuine parts from your local dealer